

Version: V1.00.000
Revised date: 11-16-2022

Trademarks

LAUNCH is a registered trademark of LAUNCH TECH CO., LTD. in China and other countries. All other marks are trademarks or registered trademarks of their respective holders.

Copyright Information

Copyright © 2022 by LAUNCH TECH CO., LTD. (also called LAUNCH for short). All rights reserved. No part of this publication may be reproduced, stored in a retrieval system, or transmitted in any form or by any means, electronic, mechanical, photocopying and recording or otherwise, without the prior written permission.

Statement: LAUNCH owns the complete intellectual property rights for the software used by this product. For any reverse engineering or cracking actions against the software, LAUNCH will block the use of this product and reserve the right to pursue their legal liabilities.

Disclaimer of Warranties and Limitation of Liabilities

All information, illustrations, and specifications in this manual are based on the latest information available at the time of publication.

The right is reserved to make changes at any time without notice. We shall not be liable for any direct, special, incidental, indirect damages or any economic consequential damages (including the loss of profits) due to the use of the document.

Using This Manual

This manual contains device usage instructions.

Some illustrations shown in this manual may contain modules and optional equipment that are not included in your system.

The following conventions are used.

Bold Text

Bold text is used to highlight selectable items such as buttons and menu options.

Example:

Tap **OK**.

Notes and Important Messages

Notes

A NOTE provides helpful information such as additional explanations, tips, and comments.

Example:



Note: Remember to remove the VCI connector from the vehicle's DLC after use.

Warning

Warning indicates a hazardous situation which, if not avoided, could result in minor or moderate injury to the operator or to bystanders.

Example:



Warning: Retrieving and using DTCs for troubleshooting vehicle operation is only one part of an overall diagnostic strategy. Never replace a part based only on the DTC definition. Each DTC has a set of testing procedures, instructions and flow charts that must be followed to confirm the location of the problem. This information can be found in the vehicle's service manual.

Danger

Danger indicates an imminently or potentially hazardous situation which, if not avoided, could result in death or serious injury to the operator or to bystanders.

Example:



Danger: If you must drive the vehicle in order to perform a troubleshooting procedure, always have a second person help you. Trying to drive and operate the diagnostic tool at the same time is dangerous, and could cause a serious traffic accident.

Illustrations

Illustrations used in this manual are samples, the actual testing screen may vary for each vehicle being tested. Observe the menu titles and on-screen instructions to make correct option selection.

Important Safety Precautions

To avoid personal injury, property damage, or accidental damage to the product, read all of the information in this section before using the tool.

DANGER

- When an engine is operating, keep the service area well-ventilated or attach a building exhaust removal system to the engine exhaust system. Engines produce various poisonous compounds (hydrocarbon, carbon monoxide, nitrogen oxides, etc.) that cause slower reaction time and result in death or serious personal injury.
- Please use the included battery and power adaptor. Risk of explosion if the battery is replaced with an incorrect type.
- DO NOT attempt to operate the tool while driving the vehicle. Have second personal operate the tool. Any distraction may cause an accident.

WARNING

- Always perform automotive testing in a safe environment.
- Do not connect or disconnect any test equipment while the ignition is on or the engine is running.
- Before starting the engine, put the gear lever in the Neutral position (for manual transmission) or in the Park (for automatic transmission) position to avoid injury.
- NEVER smoke or allow a spark or flame in vicinity of battery or engine. Do not operate the tool in explosive atmospheres, such as in the presence of flammable liquids, gases, or heavy dust.
- Keep a fire extinguisher suitable for gasoline/chemical/electrical fires nearby.
- Wear an ANSI-approved eye shield when testing or repairing vehicles.
- Put blocks in front of the drive wheels and never leave the vehicle unattended while testing.
- Use extreme caution when working around the ignition coil, distributor cap,

ignition wires and spark plugs. These components create hazardous voltage when the engine is running.

- To avoid damaging the tool or generating false data, please make sure the vehicle battery is fully charged and the connection to the vehicle DLC (Data Link Connector) is clear and secure.
- Automotive batteries contain sulfuric acid that is harmful to skin. In operation, direct contact with the automotive batteries should be avoided. Keep the ignition sources away from the battery at all times.
- Keep the tool dry, clean, free from oil, water or grease. Use a mild detergent on a clean cloth to clear the outside of the equipment when necessary.
- Keep clothing, hair, hands, tools, test equipment, etc. away from all moving or hot engine parts.
- Store the tool and accessories in a locked area out of the reach of children.
- Do not use the tool while standing in water.
- Do not expose the tool or power adapter to rain or wet conditions. Water entering the tool or power adaptor increases the risk of electric shock.
- This tool is a sealed unit. There are no end-user serviceable parts inside. All internal repairs must be done by an authorized repair facility or qualified technician. If there is any inquiry, please contact the dealer.
- Keep the tool far away from magnetic devices because its radiations can damage the screen and erase the data stored on the tool.
- Do not attempt to replace the internal rechargeable lithium battery. Contact the dealer for factory replacement.
- Do not disconnect battery or any wiring cables in the vehicle when the ignition switch is on, as this could avoid damage to the sensors or the ECU.
- Do not place any magnetic objects near the ECU. Disconnect the power supply to the ECU before performing any welding operations on the vehicle.
- Use extreme caution when performing any operations near the ECU or sensors. Ground yourself when you disassemble PROM, otherwise ECU and sensors can be damaged by static electricity.
- When reconnecting the ECU harness connector, be sure it is attached firmly, otherwise electronic elements, such as ICs inside the ECU, can be damaged.

FCC Statement

Any Changes or modifications not expressly approved by the party responsible for compliance could void the user's authority to operate the equipment.

This device complies with part 15 of the FCC Rules. Operation is subject to the following two conditions: (1) This device may not cause harmful interference, and (2) this device must accept any interference received, including interference that may cause undesired operation.

Note: This equipment has been tested and found to comply with the limits for a Class B digital device, pursuant to Part 15 of the FCC Rules. These limits are designed to provide reasonable protection against harmful interference in a residential installation.

This equipment generates, uses, and can radiate radio frequency energy, and if not installed and used in accordance with the instructions, may cause harmful interference to radio communications. However, there is no guarantee that interference will not occur in a particular installation. If this equipment does cause harmful interference to radio or television reception, which can be determined by turning the equipment off and on, the user is encouraged to try to correct the interference by one or more of the following measures:

- Reorient or relocate the receiving antenna.
- Increase the separation between the equipment and receiver.
- Connect the equipment into an outlet on a circuit different from that to which the receiver is connected.
- Consult the dealer or an experienced radio/TV technician for help.

TABLE OF CONTENTS

1 Introduction	1
1.1 Product Profile	1
1.2 Components & Controls	2
1.2.1 Display Tablet	2
1.2.2 VCI Connector	4
1.3 Technical Parameters	5
1.4 Package List	6
2 Initial Use	7
2.1 Charging & Turning On	7
2.2 Screen Layout	7
2.3 Basic Gestures	7
2.4 Change System Language	8
2.5 Adjust Brightness	8
2.6 Set Standby Time	8
2.7 Network Setup	9
3 Getting Started	10
3.1 Register & Update	10
3.2 Job Menu	12
3.3 Diagnostics Toolbar	14
4 Connections	15
4.1 Preparation	15
4.2 Vehicle Connection	15
4.2.1 OBD II vehicle Connection	16
4.2.2 Non-OBD II vehicle Connection	16
5 Diagnosis	18
5.1 Intelligent Diagnose	18
5.2 Local Diagnose	21

5.2.1 Health Report (Quick Test)	26
5.2.2 System Scan	29
5.2.3 System Selection	30
5.3 Remote Diagnose	41
5.3.1 Add Friends	42
5.3.2 Start Instant Messaging	43
5.3.3 Launch Remote Diagnosis (Device-To-Device)	44
5.3.4 Launch Remote Diagnosis (Device-To-PC)	47
5.4 Feedback	49
5.5 Diagnostic History	50
6 Service (Reset) Function	51
6.1 Maintenance Light Reset (Oil Reset)	51
6.2 Electronic Parking Brake Reset (BRAKE RESET)	51
6.3 Steering Angle Reset (SAS Reset)	51
6.4 ABS Bleeding	52
6.5 Crank Position Sensor Adaptive Learning (GEAR LEARN)	52
6.6 Anti-theft Matching (IMMO)	52
6.7 Injector Coding (INJECTOR)	52
6.8 Battery Matching (BAT. RESET)	53
6.9 DPF Regeneration (DPF REG.)	53
6.10 Throttle Matching (ELEC. THROTTLE RLRN)	53
6.11 Gearbox Matching (GEARBOX)	54
6.12 Headlight Matching (AFS RESET)	54
6.13 Sunroof Initialization (SUNROOF)	54
6.14 Suspension Level Calibration (SUS RESET)	54
6.15 EGR Adaption	54
6.16 Seats Calibration	54
6.17 Tyre Reset	55
6.18 Coolant Bleed	55
6.19 AdBlue Reset	55

6.20 NOx Sensor Reset.....	55
6.21 AC System Relearn/Initialization	55
6.22 High Voltage Battery Detection (HIGH VOLTAGE BATTERY)	55
6.23 Windows Calibration.....	55
6.24 Language Change	56
6.25 A/F Reset	56
6.26 Transport Mode	56
6.27 Stop/Start Reset	56
6.28 Intelligent Cruise Control System Reset	56
6.29 Engine Power Balance Monitoring.....	56
6.30 Gas Particulate Filter (GPF) Regeneration	57
6.31 Motor Angle Calibration	57
6.32 Tire Pressure Reset (TPMS RESET).....	57
6.33 IMMO Programming	57
7 Software Update	58
7.1 Update Diagnostic Software & APP	58
7.2 Update Frequently Used software	59
7.3 Renew Subscription.....	59
8 Add-on Modules	62
8.1 ADAS (Calibration)	62
8.2 TPMS	62
8.3 BST360 (Battery Tester).....	62
8.4 Videoscope.....	62
8.5 S2-2 Sensorbox.....	62
8.6 S2-2 Multimeter	63
8.7 PROG3 (Immobilizer Programmer).....	63
9 User Info	64
9.1 My Report.....	64
9.2 VCI	64
9.3 VCI Management	64

9.4 Activate VCI.....	64
9.5 Firmware Fix.....	65
9.6 Data Stream Sample	65
9.7 My Order	65
9.8 Subscription Renewal Card	65
9.9 Profile	65
9.10 Change password.....	66
9.11 Settings	66
9.11.1 Units	66
9.11.2 Shop Information	66
9.11.3 Printer Set	67
9.11.4 Orientation.....	70
9.11.5 Clear Cache	70
9.11.6 About.....	70
9.11.7 Diagnostic Software Auto Update	70
9.11.8 Device Account Management	70
9.11.9 Login/Logout.....	72
9.12 Diagnostic Software Clear	72
10 FAQ.....	73

1 Introduction

1.1 Product Profile

It inherits from LAUNCH's advanced diagnosing technology and is characterized by covering a wide range of vehicles, featuring powerful functions, and providing precise test result.

Through the simple wireless/USB communication between VCI (Vehicle Communication Interface) device and the display tablet, it achieves full car model and full system vehicle trouble diagnosis, which include Reading DTCs, Clearing DTCs, Reading Data Stream, Actuation Test and Special Functions.

It has the following features:

- **Intelligent Diagnose**: This module allows you to use the VIN information of the currently identified vehicle to access its data (including vehicle information, historical diagnostic records) from the cloud server to perform quick test, eliminating guesswork and step-by-step manual menu selection.
- **Local Diagnose**: Follow the on-screen prompts to start diagnostic session step by step.
- **Remote Diagnose**: This option aims to help repair shops or technicians launch instant messaging and remote diagnosis, making the repair job getting fixed faster.
- **Service Function**: It offers coding, reset, relearn and more service functions, to help vehicles get back to functional status after repair or replacement. Available tests vary by vehicle manufacturer, year, and model.
- **One-click Update**: Lets you update your diagnostic software online.
- **ADAS calibration**: Allows you to perform Advanced Driver Assistance System (ADAS) calibration operations. This function needs to be activated before normal use and only works with the specific ADAS calibration tool.
- **TPMS**: Configures the tool as a professional Tire Pressure Monitoring System (TPMS) service tool. It needs to work with the TSGUN device (sold separately) to perform all kinds of various TPMS functions.
- **Mall**: Enables you to subscribe some extra software or service functions that are not integrated in the tool online.
- **Diagnostic History**: This function provides a quick access to the tested

vehicles and users can choose to view the test report or resume from the last operation, without starting from scratch.

- **Feedback:** Enables you to submit the vehicle issue to us for analysis and troubleshooting.
- **Vehicle Coverage:** Quick dial to view the vehicle models that the tool covers.
- **Add-on modules:** Optional. BST 360 Battery Tester, S2-2 Sensorbox, Multimeter and Videoscope etc. are available as add-on modules, extending the functions of the tool.

1.2 Components & Controls

There are two main components to the diagnostic system:

- **Display Tablet** – the central processor and monitor for the system (See Chapter 1.2.1).
- **VCI Device** – the device for accessing vehicle data (See Chapter 1.2.2).

1.2.1 Display Tablet

The tablet acts as the central processing system, which is used to receive and analyze the live vehicle data from the VCI device and then output the test result.

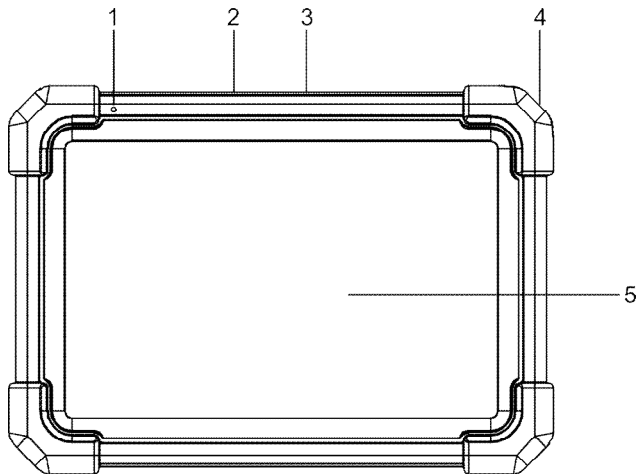

1	Microphone	
2	Type-A USB Port	<ul style="list-style-type: none">• Connects to the VCI connector to perform vehicle diagnosis via the USB cable.
3	Type-C USB Port	<ul style="list-style-type: none">• Connects to AC outlet for charging.• Connects to PC for data exchange.
4	POWER Key	<p>In Off mode, press it for 3 seconds to turn the tablet on.</p> <p>In On mode:</p> <ul style="list-style-type: none">• Press it once to activate the LCD if the LCD is off. Press it once to turn off the LCD if the LCD lights up.• Press and hold it for 3 seconds to turn it off.• Press and hold it for 8 seconds to perform forced shutdown.
5	LCD Screen	Indicates the test result.

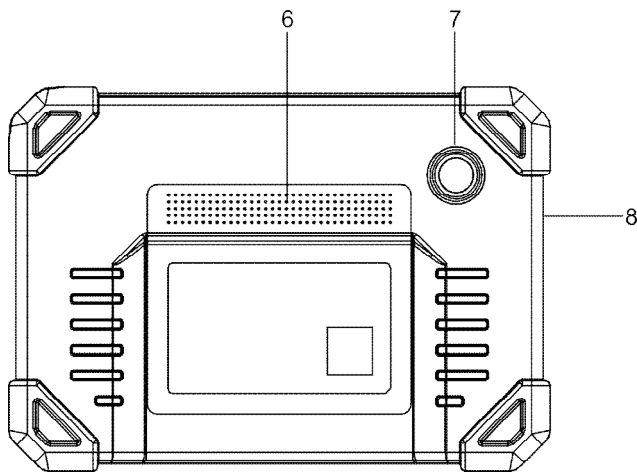

6 Speakers

7 Rear Camera

8 Microphone

1.2.2 VCI Connector

The VCI connector works as a vehicle communication interface device, which is used to connect to the vehicle's DLC (Data Link Connector) socket via the diagnostic cable to read the vehicle data and then send it to the tablet.

 Note: Remember to remove the VCI connector from the vehicle's DLC after use.

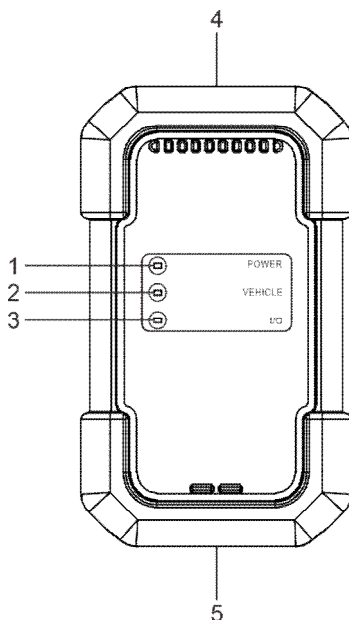

- | | | |
|---|--------------------------|---|
| 1 | Power indicator | Illuminates red while the VCI is powered up. |
| 2 | Vehicle indicator | Illuminates green and flashes when the VCI is communicating with the vehicle. |
-

3	I/O indicator	<ul style="list-style-type: none"> • Illuminates blue when the VCI is communicating with the tablet via Bluetooth. • Illuminates red when the VCI is connected to the tablet via USB cable.
4	OBD-15 diagnostic connector	Connects on vehicle's OBD II DLC via the diagnostic cable.
5	USB port	Connects the VCI to the tablet to perform vehicle diagnosis via USB cable.

1.3 Technical Parameters

Display Tablet

Operating system	Android
Memory	4GB
Storage	64GB
Screen	8 inch capacitive touch screen with a resolution of 1280 x 800 pixels
Camera	Rear-facing 8.0MP camera
Connectivity	<ul style="list-style-type: none"> • Wi-Fi (802.11a/b/g/n/ac) • Bluetooth
Working temperature	0°C ~ 50°C
Storage temperature	-20°C ~ 70°C

VCI Connector

Working voltage	9 ~ 18V
Power consumption	≤ 2.0W
Working temperature	-10°C ~ 50°C
Relative humidity	20% ~ 90%

1.4 Package List

The following packing list is for reference purpose only. For different destinations, the accessories may vary. For details, please consult from the seller or check the packing list supplied with this tool together.

No.	Item	Descriptions	Qt.
1	Display tablet	Indicates the test result.	1
2	VCI connector	A device for accessing vehicle live data.	1
3	HDB15F to HD15F data cable	<ul style="list-style-type: none"> Connects it to HD15F to OBD II 16 adaptor and the VCI for standard OBD II diagnostic socket. Connects it to non-16pin adaptor (sold separately) and the VCI for non-OBD II diagnostic socket. 	1
4	HD15F to OBD II 16 adaptor	Connects it to vehicle's OBD II diagnostic socket and the diagnostic cable.	1
5	Password envelope	A piece of paper bearing the product Serial Number and Activation Code for product registration.	1
6	Power adaptor	Charges the tablet via AC outlet.	(Optional)
7	Type-A to Type-C USB cable	<ul style="list-style-type: none"> Connects the diagnostic tool to AC outlet / PC for charging / data exchange. Connects the VCI connector to the diagnostic tool to perform vehicle diagnosis. 	1

2 Initial Use

2.1 Charging & Turning On

1. Use the included power adaptor to charge the tablet.
2. After charging is complete, press the POWER button to turn the tablet on.
The system starts initializing and then enters the home screen.

 **Note:** If the battery remains unused for a long period of time or the battery is completely discharged, it is normal that the tool will not power on while being charged. Please charge it for a period of 5 minutes and then turn it on.

 **Warning:** Please use the included power adaptor to charge your tool. No responsibility can be assumed for any damage or loss caused as a result of using power adaptors other than the one supplied.

Press [POWER] for 3 seconds, an option menu will pop up on the screen. Tap **Power off** to turn the tool off.

2.2 Screen Layout

There are five on-screen buttons available on the bottom of the screen.

 **Home:** Navigates to the Android's home screen.

 **Recent App:** Views the running applications.

 **VCI Connection:** Shows whether the VCI device is properly connected or not.

 **Screenshot:** Captures the current screen.

 **Back:** Returns to the previous screen.

2.3 Basic Gestures



Single-tap: To select an item or launch a program.



Double-tap: To zoom in so that the text on a webpage appears in a column that fits your device's screen.



Long press: Tap and hold on the current interface or area until a contextual menu pops up on the screen, and then release it.



Slide: To jump to different pages.



Drag: Tap the application icon and drop it to other location.



Spread apart/pinch together: To zoom in manually, place two fingers on the screen and then spread them apart. To zoom out, place two fingers apart on the screen and then pinch them together.

2.4 Change System Language

The tool supports multiple system languages. To change the language of the tool, please do the following:

1. On the home screen, tap **Settings -> System -> Language & input -> Languages**.
2. Tap **Add a language**, and then choose the desired language from the list.
3. Tap and hold the desired language and drag it to the top of the screen and then release it, the system will change into the target language.

2.5 Adjust Brightness

 Note: Reducing the brightness of the screen is helpful to conserve the battery power.

1. On the home screen, tap **Settings -> Display -> Brightness level**.
2. Drag the slider to adjust it.

2.6 Set Standby Time

If no activities are made within the defined standby period, the screen will be locked automatically and the system enters sleep mode to save power.

1. On the home screen, tap **Settings -> Display -> Advanced -> Sleep**.
2. Choose the desired sleep time.

2.7 Network Setup

The tablet has built-in Wi-Fi that can be used to get online. Once you're online, you can register your tool, surf the Internet, get apps, send email, launch the remote diagnosis, and check for software updates etc.

1. On the home screen, tap **Settings -> Network & Internet -> WLAN**.
2. Slide the Wi-Fi switch to ON, the tablet starts searching for available wireless networks.
3. Select a wireless network,
 - If the chosen network is open, the tablet will connect automatically.
 - If the selected network is encrypted, a network password will need to be entered.
4. When **Connected** appears, it indicates the Wi-Fi connection is complete.



Note: When Wi-Fi is not required, this should be disabled to conserve battery power.

3 Getting Started

For new users, you will need to experience a user registration process before getting started.

3.1 Register & Update

Follow the steps below to proceed registration and update:

Tap the application icon on the home screen to launch it, and then tap **Login** to enter the login interface of diagnosis software.

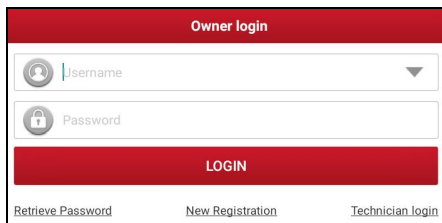

(If you are a new user, follow **A** to proceed.)

(If you have registered to be a member, go to **B** to login the system directly.)

(If you have bound a sub-account to this tool, go to **B** to login the system.)

(In case you forgot password, refer to **D** to reset a new password.)

A. If you are a new user, tap **New Registration** to enter the sign-up page.

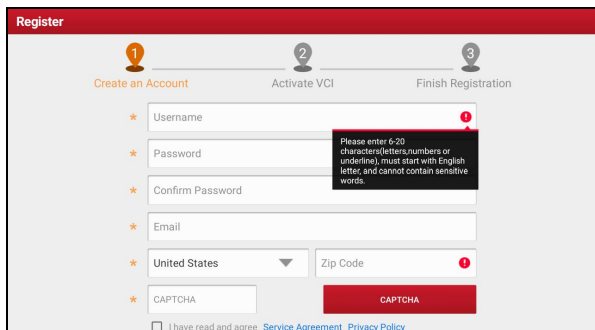

Fill in the information in each field (Items with * must be filled). After inputting,

tap **Register**, the following screen will appear:

Register

1 Create an Account 2 Activate VCI 3 Finish Registration

Serial Number

Activation Code

ACTIVATE

Your VCI's 12 digit serial number and 8 digit Activation Code can be found in the envelope pictured below.

Input the 12-digit Product Serial Number and 8-digit Activation Code (can be obtained from the password envelope), and then tap **Activate**.

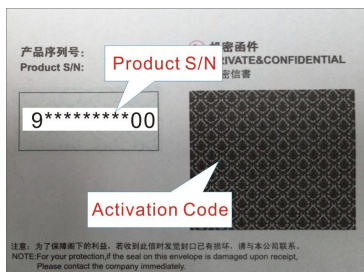

Tap **OK** to navigate to the update center to update all available software. Refer to Chapter 7 for detailed operations.

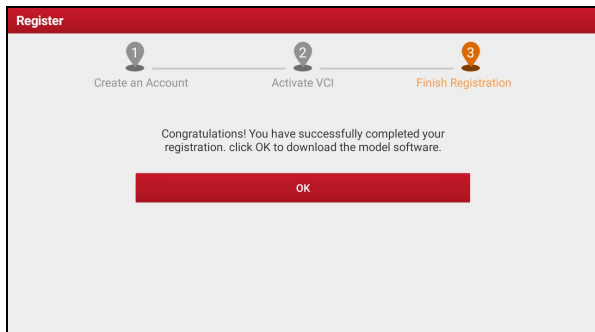

After the registration is successfully complete, the wireless communication between the tablet and the VCI device is automatically established and user has no need to configure it again.

B. If you have registered to be a member, input your name and password, and then tap **LOGIN** to enter the main menu screen directly.

E Note: The tablet has an auto-save function. Once the username and password are correctly entered, the system will automatically store it. Next time you login the system, you will not be asked to input the account manually.

C. If you have created a sub-account or bound an existing account to the tool, tap **Technician login** to login. For more details on sub-accounts, refer to Chapter 9.11.8.

D. If you forgot the password, tap **Retrieve password** and then follow on-screen instructions to set a new password.

3.2 Job Menu

It mainly includes the following items:



Name	Description
Intelligent Diagnose	<ul style="list-style-type: none"> Obtain vehicle data from the cloud server to perform quick test via reading VIN, to avoid various defects resulting from step-by-step menu selection. Check the historical repair records online.
Local Diagnose	Diagnose a vehicle manually.

Service Function	Perform commonly used repair & maintenance services.
Remote Diagnose	This option aims to help repair shops or technicians launch instant messages and remote diagnosis, making the repair job getting fixed faster.
TPMS	Configures this tool as a professional TPMS (Tire Pressure Monitoring System) service tool. It needs to work with the TSGUN device (sold separately) to perform all kinds of various TPMS functions.
Software Update	Update vehicle diagnostic software and APK.
Diagnostic History	<ul style="list-style-type: none"> • Access the diagnostic reports from the previously tested vehicles. • Resume the previous operation without starting from scratch.
Feedback	Feedback the recent 20 diagnostic logs for issue analysis.
ADAS	Perform ADAS (Advanced Driver Assistance System) calibration operations. It needs to work with the specific ADAS calibration tool (sold separately).
Mall	Subscribe some extra software or service functions that are not included in the diagnostic tool online.
Vehicle Coverage	View all the vehicle models that the tool covers.
Maintenance	Abundant maintenance data are available, which helps repair professionals diagnose and repair vehicles efficiently, accurately and profitably.
User Info	To manage my VCI, my reports, change password, configure wireless Wi-Fi printer, configure system settings and logout etc.
Other Modules	Includes some add-on modules (such as Videoscope and BST360 etc), product manual and FAQ etc.

3.3 Diagnostics Toolbar

The diagnostics toolbar contains a number of buttons that allow you to print the displayed data or make other controls. It is displayed on the upper right corner of the screen and goes through the whole diagnostic session. The table below provides a brief description for the operations of the diagnostics toolbar buttons:



Name	Button	Description
Home		Returns to Job menu screen.
Print		Tap to print the current screen. Before printing, you need to configure the wireless printer following the steps described in Chapter 9.11.3.
Exit		Exits the diagnostic application.

4 Connections

4.1 Preparation

- The vehicle ignition is turned on.
- The vehicle battery voltage range is 11-14 volts.
- The throttle is in the closed position.
- Find DLC location.

The DLC(Data Link Connector) is usually located 12 inches from the center of the instrument panel, under or around the driver's side for most vehicles. For some vehicles with special designs, the DLC location may vary. Refer to the following figure for location.

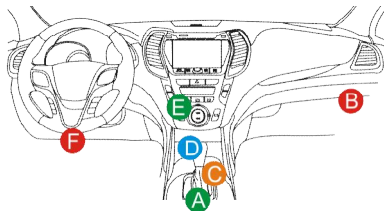

A. Opel, Volkswagen, Audi

B. Honda

C. Volkswagen

D. Opel, Volkswagen, Citroen

E. Changan

F. Hyundai, Daewoo, Kia, Honda, Toyota, Nissan, Mitsubishi, Renault, Opel, BMW, Mercedes-Benz, Mazda, Volkswagen, Audi, GM, Chrysler, Peugeot, Regal, Beijing Jeep, Citroen and other most popular models

If the DLC cannot be found, refer to the vehicle's service manual for the location.

4.2 Vehicle Connection

The method used to connect the VCI device to a vehicle's DLC depends on the vehicle's configuration as follows:

- A vehicle equipped with an OBD II management system supplies both communication and 12V power through a standardized DLC.

- A vehicle not equipped with an OBD II management system supplies communication through a DLC connection, and in some cases supplies 12V power through the cigarette lighter receptacle or a connection to the vehicle battery.

4.2.1 OBD II vehicle Connection

Use the included diagnostic cable (HDB15F to HD15F data cable + HD15F to OBD II adaptor) to connect the VCI to the vehicle's DLC port.

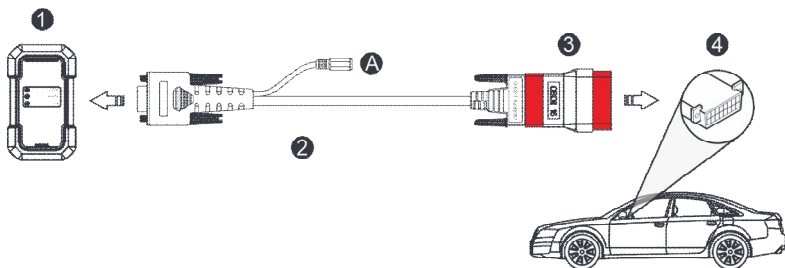

1. VCI
2. HDB15F to HD15F data cable
3. HD15F to OBD II adaptor
4. Vehicle's DLC port

4.2.2 Non-OBD II vehicle Connection

For non-OBDII vehicle, refer to the above figure to make connection.

1. Select the appropriate adaptor according to the vehicle's DLC port type (4).
2. Replace the HD15F to OBD II adaptor (3) with the target adaptor on the above figure. Other steps shall also apply.

 **Note:** If the pin of the DLC is damaged or the DLC has insufficient power, you can get power via either of the following methods:

A. Battery Clamps Cable (not included):

Connect one end of the battery clamps cable to the power jack (A) of the diagnostic cable, and the other end to the vehicle's battery.

B. Cigarette Lighter Cable (not included):

Connect one end of the cigarette lighter cable to the power jack (A) of the diagnostic

cable, and the other end to the cigarette lighter receptacle.

If you choose to perform vehicle diagnosis via data cable, connect one end of the data cable into the VCI, and the other end into the USB port of the tablet.

5 Diagnosis

5.1 Intelligent Diagnose

Through simple Bluetooth communication between the display tablet and VCI, you can easily get the VIN (Vehicle Identification Number) information of the currently identified vehicle. Once the VIN is successfully identified, the system will retrieve it from the remote server and then guide you to vehicle information page without step-by-step manual menu selection.

The vehicle information page lists all historical diagnostic records of the vehicle, which lets the technician have a total command of the vehicle faults. In addition, a quick dial to local diagnose and diagnostic function are also available on this page for reducing the roundabout time and increasing productivity.

Notes:

- Before using this function, please make sure the VCI is properly connected to the vehicle's DLC. For detailed connection, see Chapter 4.2 "Vehicle Connection".
- A stable network connection is required for this function.

1. Tap **Intelligent Diagnose** on the Job menu screen to start pairing with the VCI.

2. After pairing is complete, the tablet starts reading the vehicle VIN.

A. If the VIN can be found from the remote server database, the following screen will appear:

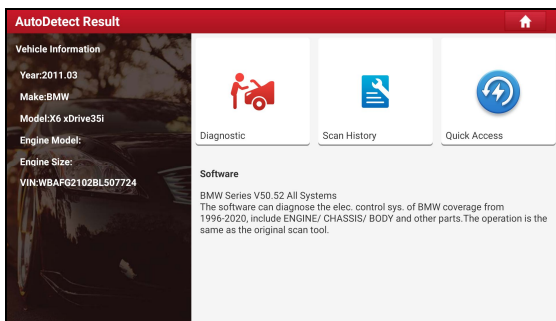

- Tap **Diagnostic** to start a new diagnostic session.

- Tap **Scan History** to view its historical repair record. If there are records available, it will be listed on the screen in sequence of date. If no records exist, the screen will show “No Record”.

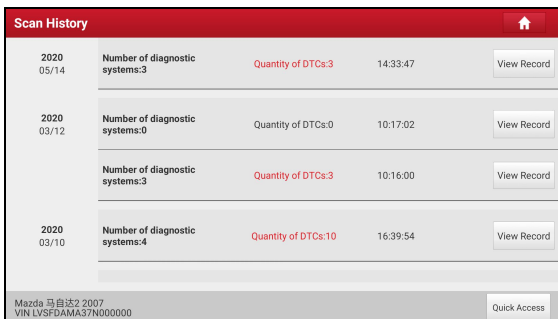

- Tap **View Record** to view the details of the current diagnostic report.
- To perform other functions, tap **Quick access** to directly go to the function selection screen. Choose the desired one to start a new diagnostic session.



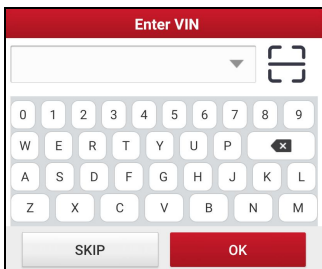

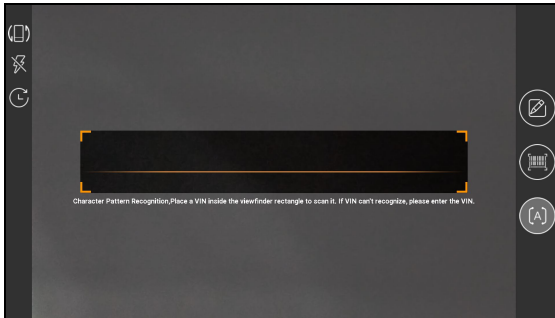

B. If the tablet failed to access the VIN information, the following screen will appear:



- Tap the input field to directly, tap **OK**. If the VIN exists on the remote server, the system will enter the diagnostic function selection screen.
- Tap [] to launch the VIN recognition module.



Place the VIN inside the viewfinder rectangle to scan it. The most recognizable location for this number is in the top left corner on the vehicle's dashboard. Other locations include the driver's door or post, and the firewall under the hood.

- Tap  to switch the display mode of the screen.
- Tap  to turn the camera flash on.
- Tap  to choose it from the record list if the VIN of the vehicle has been scanned before.
- Tap  to input the VIN manually if the tablet has failed to identify the VIN of the vehicle.
- Tap  to scan the VIN barcode. If the VIN barcode cannot be recognized, please manually input the VIN.
- Tap  to scan the VIN character. If the VIN character cannot be recognized, please manually input the VIN.

After scanning, the screen will automatically display the result.

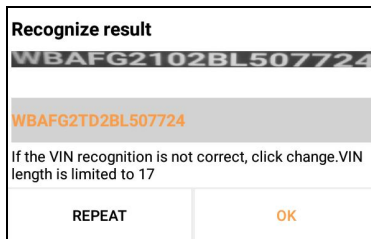

- If the VIN scanned is incorrect, tap the result field to modify it and then tap **OK**.
- To scan it again, tap **REPEAT**.

If the VIN exists on the remote server, the system will enter the diagnostic function selection screen.

5.2 Local Diagnose

In this mode, you need to execute the menu-driven command and then follow the on-screen instruction to proceed.

Tap **Local Diagnose** to enter the vehicle selection page.

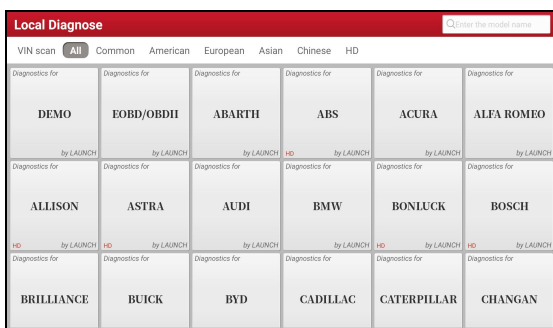

2 approaches are provided for you to access the vehicle diagnostic software. Choose any one of the following ways:

1. VIN SCAN enables you to access it more quickly.

Tap **VIN Scan**, the following screen will appear:

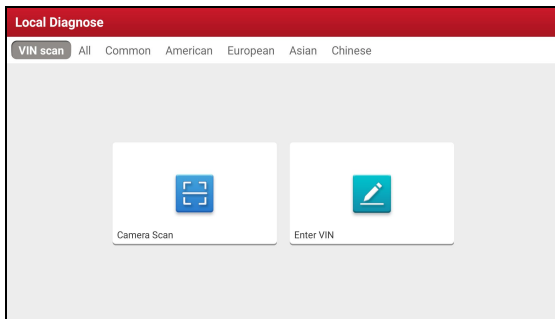



In this case, camera scan and enter VIN are available.

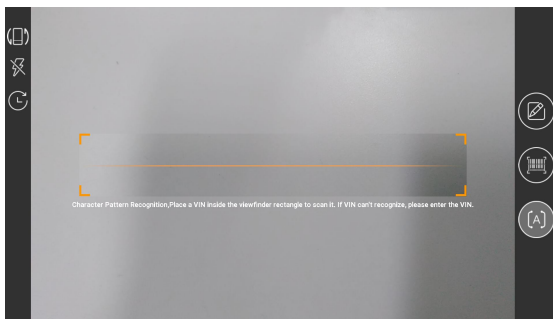

A. Camera Scan: In this mode, the VCI should be connected to the vehicle's DLC first, and then a Bluetooth communication should be established between the tablet and the VCI.

Tap **Camera Scan**, a screen similar to the following will appear:



Place the VIN inside the viewfinder rectangle to scan it. The most recognizable location for this number is in the top left corner on the vehicle's dashboard. Other locations include the driver's door or post, and the firewall under the hood.

- Tap  to switch the display mode of the screen.
- Tap  to turn the camera flash on.
- Tap  to choose it from the record list if the VIN of the vehicle has been scanned before.

- Tap  to input the VIN manually if the tablet has failed to identify the VIN of the vehicle.
- Tap  to scan the VIN barcode. If the VIN barcode cannot be recognized, please manually input the VIN.
- Tap  to scan the VIN character. If the VIN character cannot be recognized, please manually input the VIN.

After scanning, the following screen will appear.

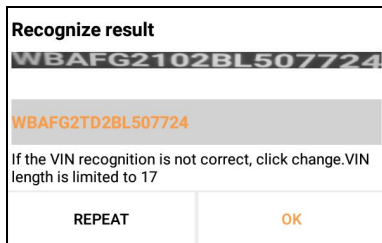

If the VIN scanned is incorrect, tap the result field to modify it and then tap **OK**. If the VIN exists on the remote server, the system will navigate to the diagnostic function selection screen directly.

Tap the desired option to perform the corresponding diagnostic function.

B. INPUT VIN: In this mode, you can input the vehicle VIN manually.

Tap **Enter VIN**, the following screen will appear.

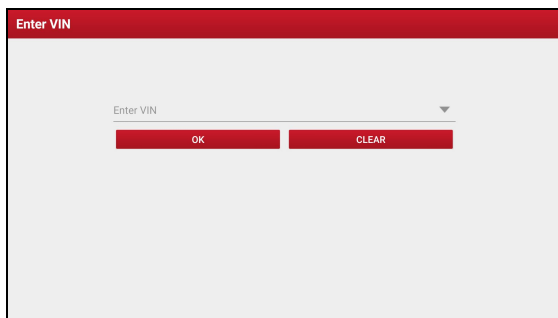

Input the VIN, and tap **OK**, the tablet will automatically identify the vehicle

model and directly navigate to the diagnostic function selection menu.

2. Tap a corresponding diagnostic software logo, and then follow the on-screen instruction to access the diagnostic software.

Take Demo (Version 15.32) as an example to demonstrate how to diagnose a vehicle.

- 1). Select diagnostic software version: Tap the **DEMO** to go to Step 2.

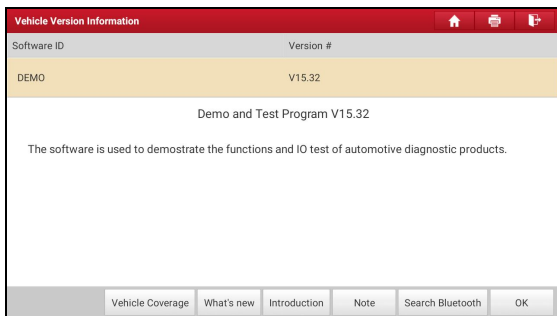

On-screen Buttons:

Vehicle Coverage: Tap to view the vehicle models that the current diagnostic software covers.

What's new: Tap to view the optimized items and enhancements.

Introduction: Tap to check the software function list.

Note: Tap to read some precautions on using the current diagnostic software.

Search Bluetooth: Tap to search for the available VCI. After the VCI is successfully activated, it will be bound to the user account and paired with the tablet automatically.



Note: No Bluetooth connection is required for DEMO program.

OK: Tap it to go to next step.

- 2). Select vehicle model (varies with different versions): Select the desired vehicle model. Here we take **Ford** for example to demonstrate how to diagnose a vehicle.

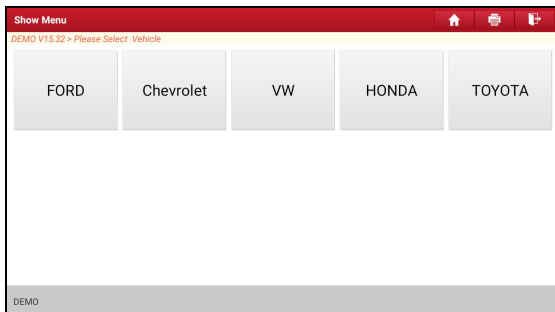

- 3). Turn the ignition key to ON: Set the ignition switch to on.

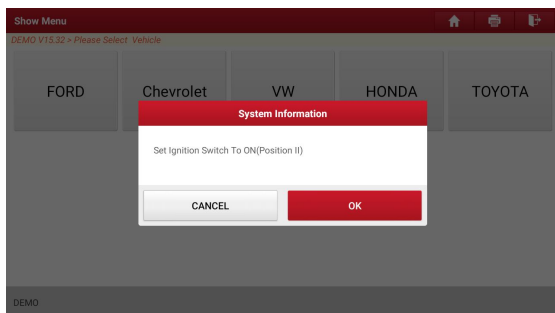

- 4). Read vehicle information: After reading the vehicle information, double check if the vehicle information is correct or not. If yes, tap **Yes** to continue.

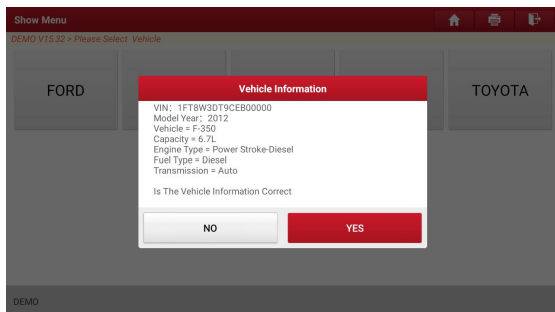

- 5). Select test item: Select the desired test item to proceed.



5.2.1 Health Report (Quick Test)

This function varies from vehicle to vehicle. It enables you to quickly access all the electronic control units of the vehicle and generate a detailed report about vehicle health.

On the test item selection screen, tap **Health Report** and turn on the ignition switch, the system will start scanning the ECUs. Once the scanning process is complete, the following screen will appear:

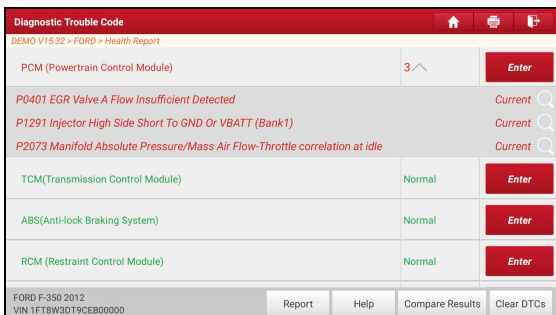

The tested system with fault code appears in red and the system functioning properly displays in black (normally).

Warning: Diagnostic Trouble Codes or Fault Codes can be used to identify which engine systems or components that are malfunctioning. Never replace a part based only on the DTC definition. Retrieving and using DTCs for troubleshooting vehicle operation is only one part of an overall diagnostic strategy. Follow testing procedures (in vehicle's service manual), instructions and flowcharts to confirm the locations of the

problem.

On-screen Buttons:

Enter: Tap to enter the diagnostic function selection screen.

(Search): Highlight certain diagnostic trouble code and tap it to retrieve it in the search engine.

Report: Tap to save the diagnostic result as a health report.

Report Information

Report Type
Pre-Repair

Vehicle Information
FORD F-350
2012 35565 km
1FT8W3DT9CEB00000 License #:

Report Info
FORD_1FT8W3DT9CEB00000_AllSystemDTC_2020051415_4114

Notes:

SKIP OK

Note: Diagnostic report is classified into three categories: Pre-Repair report, Post-Repair report and Diagnostic Scan. No matter which type you saved the report as, the report type will be appended as a tag on the upper right corner of the diagnostic report for easier identification.

Tap ▼ to select the report type from the option list and input the required information, and then tap **OK**.

Note: To facilitate the comparison of the pre-repair and post-repair reports and get accurate test result, please make sure you saved the right type of the diagnostic report.

To save the report as a common diagnostic report, select **Diagnostic Scan**.

 Note: For workshop information, tap the input box to enter it. Alternatively you can also set it in **User Info -> Settings -> Shop Information**.

Once you configured the information, it will be automatically generated every time you saved the diagnostic report. All vehicle and workshop information will be appended as tags on the diagnostic report.

To ignore the workshop information, tap **Skip** to go to the report details screen.

On the report details screen, tap **Save** to save it. All diagnostic reports are saved in **Report -> Health Report**.

Help: Tap to view the help information of the selected DTC item.

Compare Results: Tap to select the pre-repair report to compare. By comparison of the pre- and post- repair reports, you can easily identify which DTCs are cleared and which remain unfixed.

Compare Results		
DEMO V15.32 > FORD > Health Report		
DTC	Post	Pre
PCM (Powertrain Control Module)		
P0401 EGR Valve A Flow Insufficient Detected	Cleared	Found
P1291 Injector High Side Short To GND Or VBATT (Bank1)	Cleared	Found
P2073 Manifold Absolute Pressure/Mass Air Flow-Throttle correlation at idle	Cleared	Found

- **Post** indicates DTC status of post-repair.
- **Pre** indicates DTC status of pre-repair.



Note: Before performing this function, please make sure that:

- You have saved a pre-repair report of the currently tested vehicle, and
- You have already made some repairs and service and cleared the DTCs after the pre-repair reported is generated. Otherwise, no differences exist between the pre- and post- repair reports.

Clear DTCs: Tap to clear the existing diagnostic trouble codes.



Note: Clearing DTCs does not fix the problem(s) that caused the code(s) to be set. If proper repairs to correct the problem that caused the code(s) to be set are not made, the code(s) will appear again and the check engine light will illuminate as soon as the problem that cause the DTC to set manifests itself.

5.2.2 System Scan

This option allows you to quickly scan which systems are installed on the vehicle.

On the test item selection screen, tap **System Scan**, the system start scanning the systems. Once the scanning process is complete, the following screen will appear.

Select Test Item	
DEMO V15.22 > FORD > System Scan	
System Name	Result
PCM (Powertrain Control Module)	Equipped
TCM(Transmission Control Module)	Equipped
ABS(Anti-lock Braking System)	Equipped
RCM (Restraint Control Module)	Equipped
BCM(Body Control Module)	Equipped
IMMO(Immobilizer)	Equipped
APIM (Accessory Protocol Interface Module)	Equipped
FORD F-350 2012 VIN 1FT8W3D19CEB00000	

Tap the desired system to go to the diagnostic function selection screen. For detailed operations on diagnostic function, please refer to Chapter 5.2.3.

5.2.3 System Selection

This option allows you to manually select the test system and function step by step.

On the test item selection screen, tap **System Selection**, the screen displays as follows:

Show Menu	
DEMO V15.22 > FORD > System Selection	
PCM (Powertrain Control Module)	TCM(Transmission Control Module)
ABS(Anti-lock Braking System)	RCM (Restraint Control Module)
BCM(Body Control Module)	IMMO(Immobilizer)
APIM (Accessory Protocol Interface Module)	PAM (Parking Assist Module)
ICM1 (Information Center Module)	DDM (Driver Door Module)
DSM (Driver Seat Module)	DSP (Digital Signal Processor)
FORD F-350 2012 VIN 1FT8W3D19CEB00000	

Swipe the screen from the bottom to view the vehicle system on the next page.

Tap the target system (take **ECM** for example) to navigate to the diagnostic function selection screen.

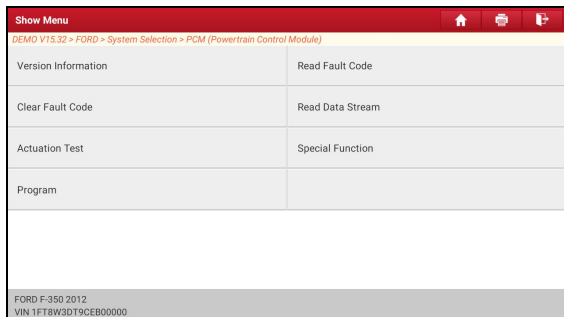

 Note: Different vehicle has different diagnostic menus.

A. Version Information

This function is used to read the version information of system mode, vehicle VIN, software and ECU.

B. Read Fault Code

This function displays the detailed information of DTC records retrieved from the vehicle's control system.

 **Caution:** Retrieving and using DTCs for troubleshooting vehicle operation is only one part of an overall diagnostic strategy. Never replace a part based only on the DTC definition. Each DTC has a set of testing procedures, instructions and flow charts that must be followed to confirm the location of the problem. This information can be found in the vehicle's service manual.

On the diagnostic function selection screen, tap **Read Fault Code**, the screen will display the diagnostic result.

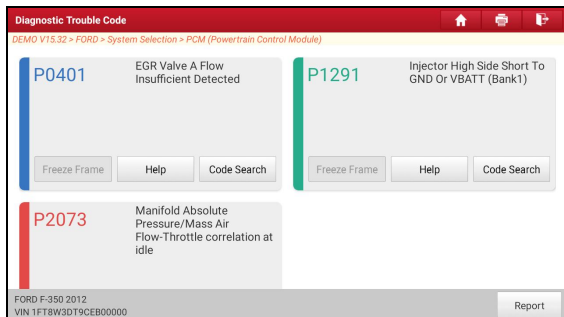

On-screen Buttons:

Freeze Frame: When an emission-related fault occurs, certain vehicle conditions are recorded by the on-board computer. This information is referred to as freeze frame data. Freeze frame data includes a snapshot of critical parameter values at the time the DTC is set.

Help: Tap to view the help information.

Code Search: Tap to search for more information about the current DTC online.

Report: Tap to save the current data in text format. All reports are saved in **Report -> Health Reports**.

C. Clear Fault Code

This function enables you to erase the codes from the vehicle after reading the retrieved codes from the vehicle and certain repairs have been carried out. Before performing this function, make sure the vehicle's ignition key is in the ON position with the engine off.

Clearing DTCs does not fix the problem(s) that caused the code(s) to be set. If proper repairs to correct the problem that caused the code(s) to be set are not made, the code(s) will appear again and the check engine light will illuminate as soon as the problem that cause the DTC to set manifests itself.

On the diagnostic function selection screen, tap **Clear Fault Code**, the following screen will appear.

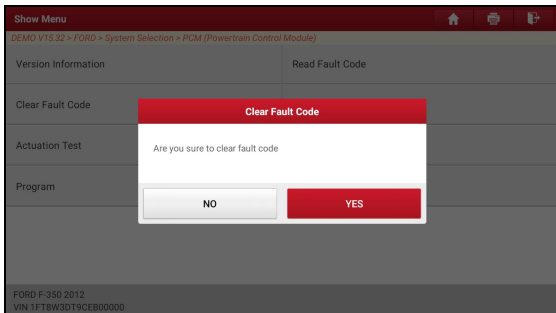



Tap **YES**, the system will automatically delete the currently existing trouble code.

 Note: After clearing, you should retrieve trouble codes once more or turn ignition on and retrieve codes again. If there are still some trouble codes in the system, please troubleshoot the code using a factory diagnosis guide, then clear the code and recheck.

D. Read Data Stream

This option lets you view and capture (record) real-time Live Data. This data including current operating status for parameters and/or sensor information can provide insight on overall vehicle performance. It can also be used to guide vehicle repair.

 Caution: If you must drive the vehicle in order to perform a troubleshooting procedure, ALWAYS have a second person help you. Trying to drive and operate the diagnostic tool at the same time is dangerous, and could cause a serious traffic accident.

 Note: The real time (Live Data) vehicle operating information (values/status) that the on-board computer supplies to the tool for each sensor, actuator, switch, etc. is called Parameter Identification Data (PID).

On the diagnostic function selection screen, tap **Read Data Stream**, the following screen will appear.

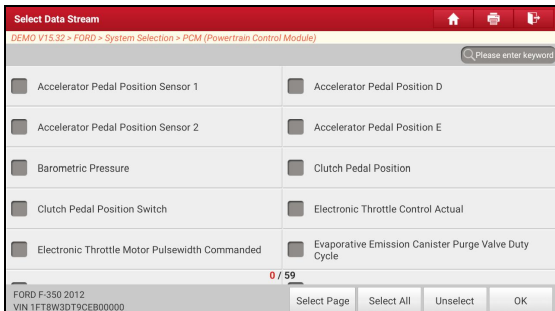

On-screen Buttons:

Select Page: Tap to select all items of the current page.

Select All: Tap to select all items. To select certain data stream item, just check the box before the item name.

Unselect: Tap to deselect all data stream items.

OK: Tap to confirm and jump to the next step.

After selecting the desired items, tap **OK** to enter the data stream reading page.

Name	Value	English	Metric
Accelerator Pedal Position Sensor 1	1.11	V	
Accelerator Pedal Position D	19.61	%	
Accelerator Pedal Position Sensor 2	0.57	V	
Accelerator Pedal Position E	21.18	%	
Barometric Pressure	99.5	kPa	

Notes:

1. Tap , the following popup will appear.

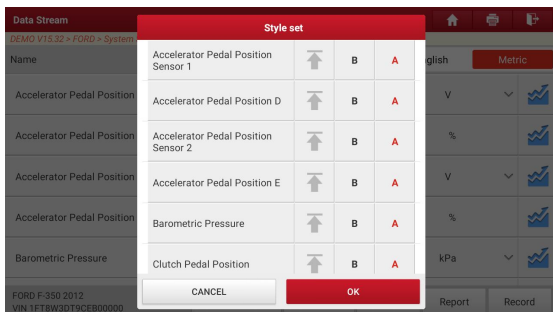

Here the user can set different display style for each selected item.

↑ indicates sticky top. If it is tapped, it will change into ↑. On the data stream display screen, the data stream item with ↑ will be shown on the top of the selected data stream list. To remove it from the top of the list, just tap it again.

B indicates this item will be displayed in **Bold**.

A indicates this item will be displayed in **Red**.

2. Tap English or Metric to switch the measurement unit.
3. If the value of the data stream item is out of the range of the standard (reference) value, the whole line will display in red. If it complies with the reference value, it displays in blue (normal mode).
4. The indicator 1/X shown on the bottom of the screen stands for the current page/total page number. Swipe the screen from the right/left to advance/return to the next/previous page.

There are 3 types of display modes available for data viewing, allowing you to view various types of parameters in the most suitable way.

- ✓ Value – This is the default mode which displays the parameters in texts and shows in list format.
- ✓ Graph – Displays the parameters in waveform graphs.
- ✓ Combine – This option is mostly used in graph merge status for data comparison. In this case, different items are marked in different colors.

On-screen Buttons:

 **Graph(Single):** Tap to view the parameter in waveform graph.

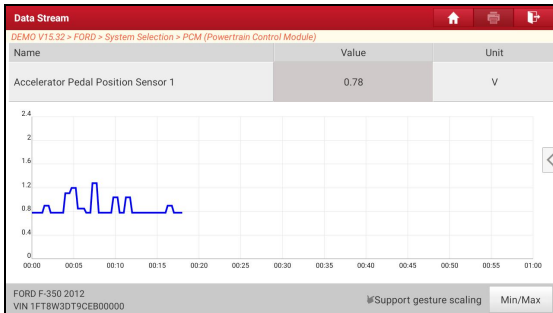

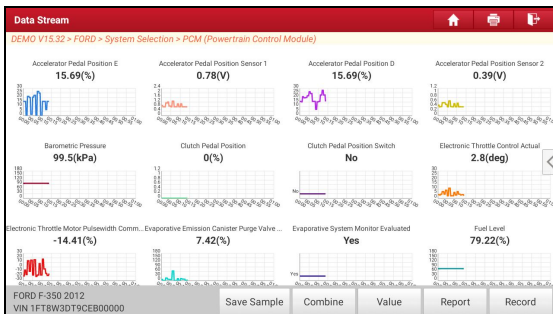

- **Min/Max:** Tap to define the maximum / minimum value. Once the value goes beyond the specified value, the system will alarm.

Graph: Tap to view the parameters in waveform graphs.

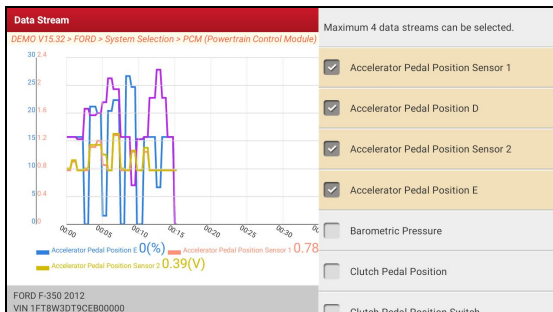

- **Combine:** This option is mostly used in graph merge status for data comparison. In this case, different items are marked in different colors (maximum 4 items can be displayed on the same screen simultaneously). If the graph is more than one page, swipe the screen from the left to jump to the next page.



- **Value:** Switches the current graph display mode to the Value display mode.
- **Customize:** Tap , a pull-down list of the data stream items appears on the screen. Select / deselect the desired items, and then screen will display / remove the waveforms corresponding to these items immediately.

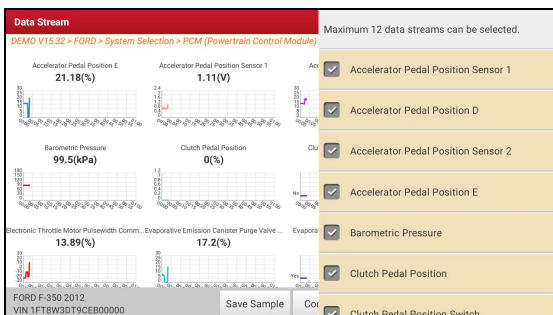

Compare Sample: Tap to select the sample DS file.

All the values you customized and saved in process of DS sampling will be imported into the **Standard Range** (See below) column for your comparison.

 **Note:** Before executing this function, you have to sample the values of data stream items and save it as a sample Data Stream file.

Data Stream					
DEMO V15.32 > FORD > System Selection > PCM (Powertrain Control Module)					
Name	Value	Standard Range(Data Stream Sample)	English	Metric	
Accelerator Pedal Position Sensor 1	0.78	0.78 - 1.8	V	[Graph Icon]	
Accelerator Pedal Position D	22.75	10 - 27.84	%	[Graph Icon]	
Accelerator Pedal Position Sensor 2	0.39	0.23 - 0.57	V	[Graph Icon]	
Accelerator Pedal Position E	15.69	0 - 24.71	%	[Graph Icon]	
Barometric Pressure	99.5	52.5 - 99.5	kPa	[Graph Icon]	
FORD F-350 2012 VIN 1FT8W3D79CEB00000					
Compare Sample		Save Sample	Graph	Report	Record

Report: Tap to save the current data in text format. All reports are saved in **Report -> Health Reports**. For details on report operations, please refer to Chapter 5.6.

Record: Tap to start recording diagnostic data. Recorded live data can serve as valuable information to help you in troubleshooting of vehicle problems.

Data Stream					
DEMO V15.32 > FORD > System Selection > PCM (Powertrain Control Module)					
Name	Value	Standard Range(Data Stream Sample)	English	Metric	
Accelerator Pedal Position Sensor 1	1.11		V	[Graph Icon]	
Accelerator Pedal Position D	19.61		%	[Graph Icon]	
Accelerator Pedal Position Sensor 2	0.57		V	[Graph Icon]	
Accelerator Pedal Position E	21.18		%	[Graph Icon]	
Barometric Pressure	99.5		kPa	[Graph Icon]	
FORD F-350 2012 VIN 1FT8W3D79CEB00000					
Compare Sample		Save Sample	Graph	Report	Record

Tap  to end recording and save it. The saved file follows the naming rule: It begins with vehicle type, and then the product S/N and ends with record starting time (To differentiate between files, please configure the accurate system time).

All diagnostic records can be replayed from **Report -> Recorded Data**.

Save Sample: This item enables you to customize the standard range of live data stream items and save it as DS sample file. Each time you run the data stream items, you can call out the corresponding sample data to overwrite the current standard range.

Tap it to start recording the sample data  Note: Only data stream items with

measurement units will be recorded), the following screen will appear:

The screenshot shows the 'Data Stream' interface. At the top, it displays 'DEMO V15.32 > FORD > System Selection > PCM (Powertrain Control Module)'. Below this is a table with columns: Name, Value, Unit, and a graph icon. A red overlay with a stop button and the text 'Data Stream Sample Recording' is positioned over the 'Barometric Pressure' row, which shows a value of 99.5 and a unit of KPa. At the bottom, there are buttons for 'Compare Sample', 'Save Sample', 'Graph', 'Report', and 'Record'.

Name	Value	Unit	Graph
Accelerator Pedal Position Sensor 1	0.78	V	Graph
Accelerator Pedal Position D	15.69	%	Graph
Accelerator Pedal Position Sensor 2	0.4	V	Graph
Accelerator Pedal Position E	0	%	Graph
Barometric Pressure	99.5	KPa	Graph

Vehicle Info: FORD F-350 2012, VIN 1FTBW3DTRCEB00000

Once the recording process is complete, tap  to stop it and navigate to the data revision screen.

The screenshot shows the 'Confirm Sample DS' interface. It displays a table with columns: Name, Min Value, Max Value, and Unit. Each Max Value cell contains a red 'X' icon, indicating it can be edited. A 'Save' button is located at the bottom right.

Name	Min Value	Max Value	Unit
Accelerator Pedal Position D	0.0	27.84	%
Accelerator Pedal Position E	0.0	24.71	%
Accelerator Pedal Position Sensor 1	0.78	1.11	V
Accelerator Pedal Position Sensor 2	0.39	0.57	V
Barometric Pressure	99.5	99.5	Kpa

Vehicle Info: FORD F-350 2012, VIN 1FTBW3DTRCEB00000

Tap the Min./Max. value to change it. After modifying all desired items, tap **Save** to save it as a sample DS file. All DS files are stored in **User Info -> Data Stream Sample**.

E. Actuation Test

This option is used to access vehicle-specific subsystem and component tests. Available test vary by vehicle manufacturer, year, and model.

During the actuation test, the display tablet outputs commands to the ECU in order to drive the actuators, and then determines the integrity of the system or parts by reading the ECU data, or by monitoring the operation of the actuators, such as switching an injector between two operating states.

On the diagnostic function selection screen, tap **Actuation Test**, the following screen will appear:

Show Menu	
DEMO V15.32 > FORD > System Selection > PCM (Powertrain Control Module)	
Air Conditioning Compressor Commanded State	Service Tool Fuel Multiplier For Cylinder 1
Service Tool Fuel Multiplier For Cylinder 2	Service Tool Fuel Multiplier For Cylinder 3
Service Tool Fuel Multiplier For Cylinder 4	Service Tool Fuel Multiplier For Cylinder 5
Service Tool Fuel Multiplier For Cylinder 6	Service Tool Fuel Multiplier For Cylinder 7
Service Tool Fuel Multiplier For Cylinder 8	Commanded Exhaust Gas Recirculation a Duty Cycle or Position
Commanded Fuel Rail Pressure A	Desired Idle Speed RPM
FORD F-350 2012 VIN 1FTB73D19CEB00000	

Simply follow the on-screen instructions and make appropriate selections to complete the test.

Actuation Test	
DEMO V15.32 > FORD > System Selection > PCM (Powertrain Control Module)	
Select Test Item	Result
Air Conditioning Compressor Commanded State	
<div style="display: flex; justify-content: space-around; margin-top: 20px;"> Monitor On Off </div>	
FORD F-350 2012 VIN 1FTB73D19CEB00000	

Each time when an operation is successfully executed, *Completed* displays.

5.3 Remote Diagnose

This module helps repair shops or mechanics to diagnose a remote vehicle, and launch instant messages, allowing for improved efficiency and faster repairs.

Tap **Remote Diagnose** on the Job menu, the screen appears blank by default.

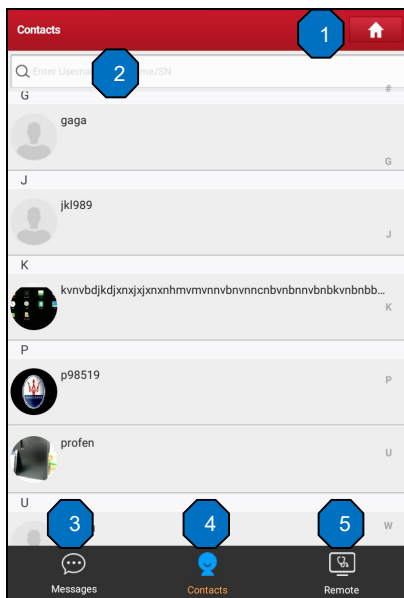

1	Home Button	Navigate to the Job menu screen.
2	Search Bar	Directly input the username of the tool for searching, and then tap the desired one to add it into Contacts list.
3	Messages Tab	A red dot will appear indicating a received message.
4	Contacts Tab	Enter the friend list.
5	Remote Switch	Your technician can control your tool remotely once the switch is ON.

5.3.1 Add Friends

Tap **Contacts**. By default it appears blank.

In the search bar, input the partner's username and tap **Search** to start searching.

The partner must be the users who have registered specific diagnostic tools. They may be the following:

- Workshop
- Technician
- golo users

Once the result matches the keyword, the following screen will appear:

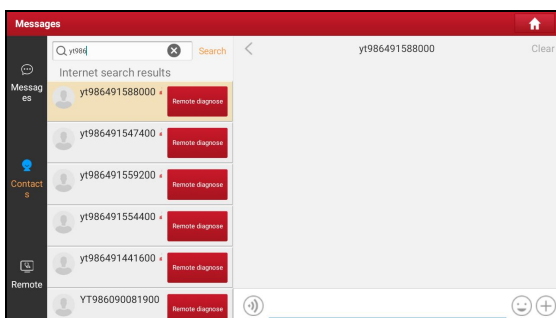

Here you can tap **Remote Diagnose** to launch remote diagnostics directly or choose to add the partner into the Contacts list.

Tap the desired name from the list, the following screen will appear:

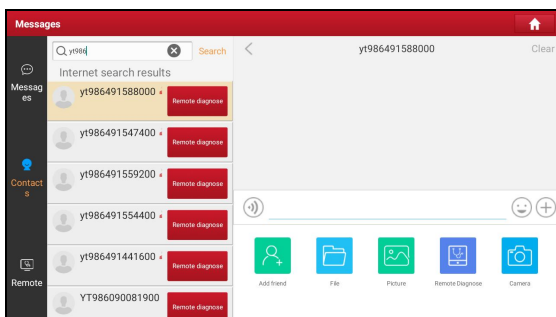

Tap **Add friend** to send your request.

Once the partner receives the request, a beep will sound. Tap **Messages**:

- Once the partner agreed your request, he/she will automatically be listed in the Contacts tab.
- If a technician sent you a friend request, tap **Agree** and his/her name will appear in the Contacts list. Or tap **Ignore** to ignore this request.

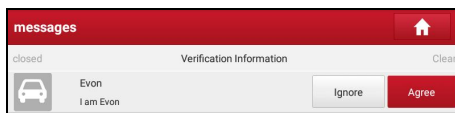

5.3.2 Start Instant Messaging

The I/M (Instant Messaging) function is open to all users who had the diagnostic tool equipped with this module.

After adding your friends, tap the desired one's photo to enter the following screen:

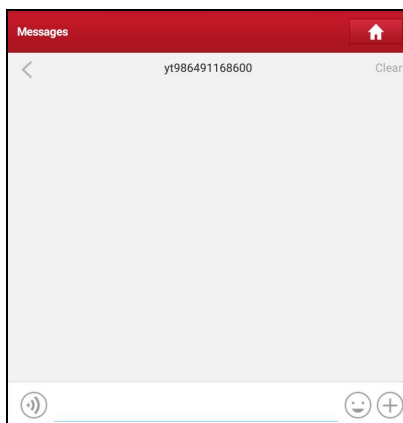

Tap the input field and use the on-screen keyboard to send the text message.

Tap  to send the voice message.

Tap  to send the emoji.

Tap  to call out more function options.

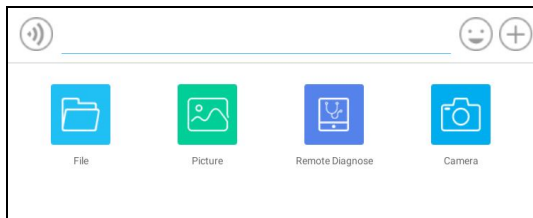

File: Choose diagnostic reports or local files to send.

Picture: Choose screenshots or pictures to send.

Remote Diagnose: To start a remote diagnostic session. For details, refer to Chapter 5.3.4.

Camera: Open camera to take pictures.



5.3.3 Launch Remote Diagnosis (Device-To-Device)

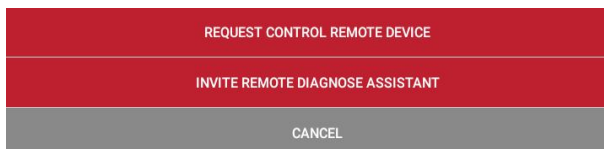

The tool is allowed to initiate remote diagnosis with other diagnostic tools, which are equipped with this module.

On the function option selection screen, tap **Remote Diagnostic**, the following pull-down menu will appear:



These options are defined as follows:

Actions	Results
Request control remote device	<p>Request to control the partner's device remotely to help him diagnose the vehicle.</p> <p> Notes:</p> <ul style="list-style-type: none"> • In process of remote diagnosis, tap the  button to send a voice message. • Once vehicle diagnosis is complete, a report will be created. Input your comments on this report, and then tap Send Report to send it to the partner.

	<pre>graph TD; A[Tap "Request control remote device"] --> B[Wait for partner's confirmation]; B --> C[Start connecting after request confirmed]; C --> D[Start Diagnosis]; D --> E[Generate diagnostic report];</pre>
Invite remote diagnostic assistant	<p>Use this option to invite a technician to perform a remote control on your tool.</p> <p> Notes:</p> <ul style="list-style-type: none">• In process of remote diagnosis, tap the  button to send a voice message.• Once you received the report from the partner, tap View Report to view details. All diagnostic reports are saved under Report -> Remote Report.

	<pre>graph TD; A[Tap "Invite remote diagnostic assistant"] --> B[Choose the desired diagnostic software]; B --> C[Wait for partner's confirmation]; C --> D[Start connecting after request confirmed]; D --> E[Start Diagnosis]; E --> F[Generate diagnostic report];</pre>
Cancel	To cancel this operation.

5.3.4 Launch Remote Diagnosis (Device-To-PC)

User also can ask for remote control from a PC client technician.

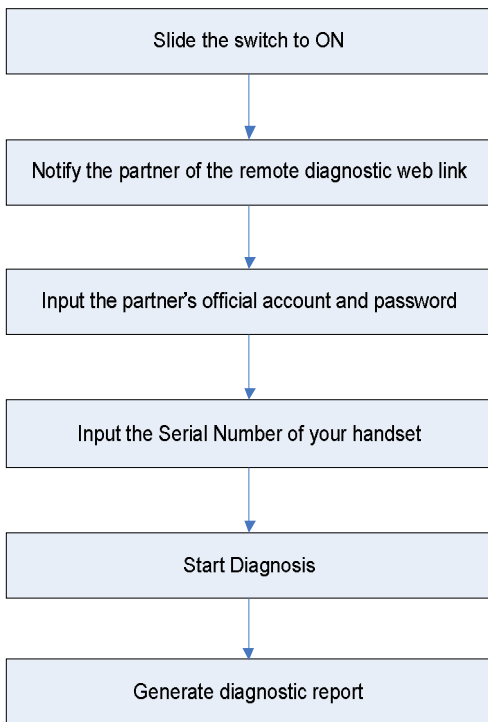

Tap **Remote**, the following screen will appear:

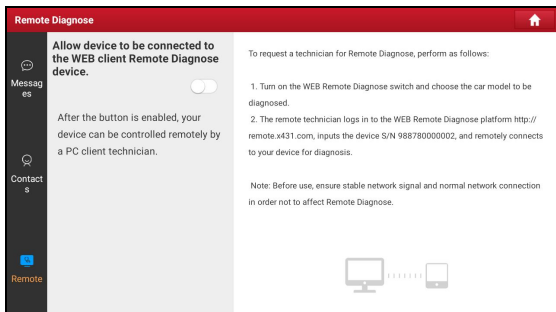

1. Slide the switch to ON so that the partner can find and connect to this device while using the PC.
2. Notify the partner of the PC client website <http://remote.x431.com>. When the partner accesses the link, the PC displays as below:

 Note: Before processing remote diagnosis, please make sure the tool is properly connected to the vehicle.

3. Tell the partner to input his own official technician account and password, and then tap **Login** to navigate to the following figure.

Remote diagnosis

Serial Number
Locate the car to be diagnosed according to golo/AIT serial number

License Plate Number
Locate the car to be diagnosed according to the car owner's license plate number

Phone Number
Locate the car to be diagnosed according to the car owner's phone number

Start remote diagnosis

Tips: Before starting remote diagnosis, confirm the car owner's car information and condition

4. Tell the partner to enter the Serial Number provided by you, and then tap **Start remote diagnosis** to control your device remotely.

In process of remote diagnosis, please note the following things:

- 1) You are not suggested to execute any actions.
- 2) The partner is not allowed to save any diagnostic reports or records on your tablet.

Once the session is complete, a remote diagnostic report will be automatically generated.

5.4 Feedback

This function enables you to feedback the diagnostic issues to us for analysis and troubleshooting.

Tap **Feedback**, and tap **OK** to enter into the vehicle diagnostic record page.

A. Feedback

Tap the target vehicle to enter the feedback page.

B. History

Tap it to view the diagnostic feedback logs which are marked with different color indicating the process status of the diagnostic feedback.

C. Offline list

Tap it to enter the diagnostic feedback offline list page. Once the tablet gets a stable network signal, it will be uploaded to the remote server automatically.

5.5 Diagnostic History

This function enables users to directly get access to the previously tested vehicle's diagnostic records in details, so users can resume from the last operation, without starting from scratch.

Tap **Diagnostic History** on the Job menu screen, all diagnostic records will be listed on the screen in date sequence.

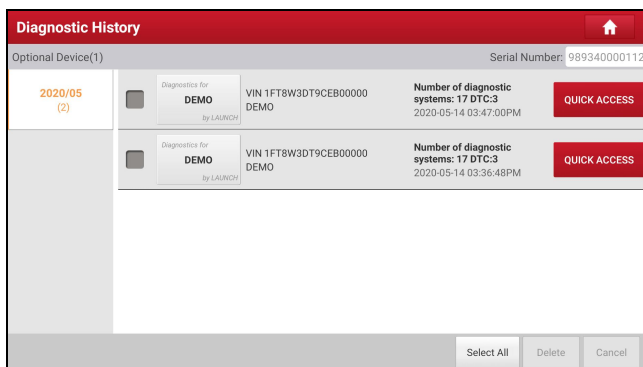

- Tap certain vehicle model to view the details of the last diagnostic report.
- To delete certain diagnostic history, select it and then tap **Delete**. To delete all historical records, tap **Select All** and then tap **Delete**.
- Tap **Quick access** to directly navigate to the function selection page of last diagnostic operation. Choose the desired option to proceed.

6 Service (Reset) Function

It offers coding, reset, relearn and more service functions, to help vehicles get back to functional status after repair or replacement. Available tests vary by vehicle manufacturer, year, and model.

Due to continuing improvements, the available service functions are subject to change at any time. To enjoy more service functions, you are suggested to check for updates on a regular basis.

6.1 Maintenance Light Reset (Oil Reset)

This function enables you to reset the oil service for the engine oil life system, which calculates an optimal oil life change interval depending on the vehicle driving conditions and weather events.

It needs to be performed in the following cases:

1. If the service lamp is on, run car diagnostics first for troubleshooting. After that, reset the driving mileage or driving time, so as to turn off the service lamp and enable a new driving cycle.
2. If the service lamp is not on, but you have changed the engine oil or electric appliances that monitor oil life, you need to reset the service lamp.

6.2 Electronic Parking Brake Reset (BRAKE RESET)

This function enables you to reset the brake pad after replacing the brake pad.

It needs to be performed in the following cases:

1. The brake pad and brake pad wear sensor are replaced.
2. The brake pad indicator lamp is on.
3. The brake pad sensor circuit is short, which is recovered.
4. The servo motor is replaced.

6.3 Steering Angle Reset (SAS Reset)

This function enables you to reset the steering angle, after replacing the steering angle position sensor, replacing steering mechanical parts (such as steering

gearbox, steering column, end tie rod, steering knuckle), performing four-wheel alignment, or recovering car body.

To reset the steering angle, first find the relative zero point position for the car to drive in straight line. Taking this position as reference, the ECU can calculate the accurate angle for left and right steering.

6.4 ABS Bleeding

This function allows you to perform various bi-directional tests to check the operating conditions of Anti-lock Braking System (ABS).

It needs to be performed in the following cases:

1. When the ABS contains air.
2. When the ABS computer, ABS pump, brake master cylinder, brake cylinder, brake line, or brake fluid is replaced.

6.5 Crank Position Sensor Adaptive Learning (GEAR LEARN)

This function can perform gear learning for the car, to turn off the related Malfunction Indicator Light (MIL).

It needs to be performed in the following cases:

1. After the engine ECU, crankshaft position sensor, or crankshaft flywheel is replaced.
2. The DTC "tooth not learned" is present.

6.6 Anti-theft Matching (IMMO)

This function can match the anti-theft key after replacing the ignition key, ignition switch, instrument cluster, engine control unit (ECU), body control module (BCM), and remote control battery.

6.7 Injector Coding (INJECTOR)

This function enables you to write injector actual code or rewrite code in the ECU to the injector code of the corresponding cylinder, so as to more accurately

control or correct cylinder injection quantity.

It needs to be performed in the following cases:

After the ECU or injector is replaced.

6.8 Battery Matching (BAT. RESET)

This function enables you to perform a resetting operation on the monitoring unit of vehicle battery, in which the original low battery fault information will be cleared and battery matching will be done.

It needs to be performed in the following cases:

1. The main battery is replaced.
2. The battery monitoring sensor is replaced.

6.9 DPF Regeneration (DPF REG.)

This function enables you to clear PM (Particulate Matter) from the DPF filter through continuous combustion oxidation mode (such as high temperature heating combustion, fuel additive or catalyst reduce PM ignition combustion) to stabilize the filter performance.

It needs to be performed in the following cases:

1. The exhaust back pressure sensor is replaced.
2. The PM trap is removed or replaced.
3. The fuel additive nozzle is removed or replaced.
4. The catalytic oxidizer is removed or replaced.
5. The DPF regeneration MIL is on and maintenance is performed.
6. The DPF regeneration control module is replaced.

6.10 Throttle Matching (ELEC. THROTTLE RLRN)

This function enables you to make initial settings to throttle actuators and returns the learned values stored on ECU to the default state. Doing so can accurately control the actions of regulating throttle (or idle engine) to adjust the amount of air intake.

6.11 Gearbox Matching (GEARBOX)

This function enables you to complete the gearbox self-learning to improve gear shifting quality.

It needs to be performed in the following cases:

When the gearbox is disassembled or repaired.

6.12 Headlight Matching (AFS RESET)

This function enables you to initialize the adaptive headlamp system.

6.13 Sunroof Initialization (SUNROOF)

This function enables you to set the sunroof lock off, closed when it rains, sliding / tilting sunroof memory function, temperature threshold outside the car etc.

6.14 Suspension Level Calibration (SUS RESET)

This function enables you to adjust the height of the body.

It needs to be performed in the following cases:

1. When replacing the body height sensor, or control module in the air suspension system.
2. When the vehicle height is incorrect.

6.15 EGR Adaption

This function is used to learn the EGR (Exhaust Gas Recirculation) valve after it is cleaned or replaced.

6.16 Seats Calibration

This function is applied to match the seats with memory function that are replaced and repaired.

6.17 Tyre Reset

This function is used to set the size parameters of the modified or replaced tire.

6.18 Coolant Bleed

Use this function to activate the electronic water pump before venting the cooling system.

6.19 AdBlue Reset

After the diesel exhaust treatment fluid (car urea) is replaced or filled up, urea reset operation is required.

6.20 NOx Sensor Reset

NOx sensor is a sensor used to detect the content of nitrogen oxides (NOx) in engine exhaust. If the NOx fault is re-initialized and the NOx catalytic converter is replaced, it is necessary to reset the catalytic converter learned value stored in the engine ECU.

6.21 AC System Relearn/Initialization

AC system relearn/initialization must be performed when the vehicle AC ECU or actuator is replaced or the ECU memory is lost.

6.22 High Voltage Battery Detection (HIGH VOLTAGE BATTERY)

This function is used for high voltage battery diagnosis and status information detection.

6.23 Windows Calibration

This function is used to perform door window matching to recover the ECU initial memory, and recover the automatic ascending and descending function of

power window.

6.24 Language Change

This function is used to change system language of vehicle center console.

6.25 A/F Reset

This function is applied to set or learn air/fuel rate parameters.

6.26 Transport Mode

To lower vehicle power consumption, user may perform the following operations: limit vehicle speed, not wake up the network for door open and disable remote key etc. In this case, deactivating transport mode is needed to recover vehicle being normal.

6.27 Stop/Start Reset

This function is used to open or close the automatic Start/Stop function via setting the hidden function in ECU (The precondition is vehicle equipped with hidden function and hardware support).

6.28 Intelligent Cruise Control System Reset

This function is used to matching the intelligent cruise control module after it is replaced or repaired.

6.29 Engine Power Balance Monitoring

This function is used to monitor crankshaft acceleration in the power stroke of each cylinder, to determine the relative power provided by each cylinder.

6.30 Gas Particulate Filter (GPF) Regeneration

This function is used to perform the GPF replacement or regeneration after the fuel consumption is increased and engine output power is reduced resulting from a long time service of the GPF.

6.31 Motor Angle Calibration

This function is used to perform the motor angle calibration when the rotor position detected by the motor angle position sensor is different from the actual rotor field position.

6.32 Tire Pressure Reset (TPMS RESET)

This function can reset the tire pressure and turn off the tire pressure fault indicator when the car tire pressure fault indicator light is on.

6.33 IMMO Programming

This function enables you to perform read-write function for vehicle key, EEPROM, MCU, and EEPROM/FLASH data of vehicle engine/gearbox ECU.

7 Software Update

This module enables you to update the diagnostic software & App and frequently used software.

7.1 Update Diagnostic Software & APP

Go to **Software Update** on the Job Menu and tap the **Downloaded** tab.

The **Available** tab displays a list of software that can be updated. Under it, all software is categorized into three kinds:

- **Common software:** mainly includes some common apps that are associated with the diagnostic app. The software of this kind always stays at the top of the list, which can be deselected manually (excluding the system app, such as firmware and ECU aid).
 - **Frequently used vehicle software:** refers to the diagnostic software that is frequently used, including the vehicle diagnostic software and Reset software. It is generally displayed following the **Common software** list.
 - **Other vehicle software:** refers to the diagnostic software that is rarely used or never used. It is generally displayed following the **Frequently used software** list.
- 1). If the user does not download any diagnostic software during the sign-up process, all diagnostic software is selected by default. Tap **Update** to start downloading.
 - 2). If the user downloaded all/some vehicle software during the sign-up process and had it serviced for a long period of time, only the frequently used software is selected. Tap **Update** to start downloading. Other vehicle software that is rarely used will also be listed under the **Available** tab, but it is not selected at default.

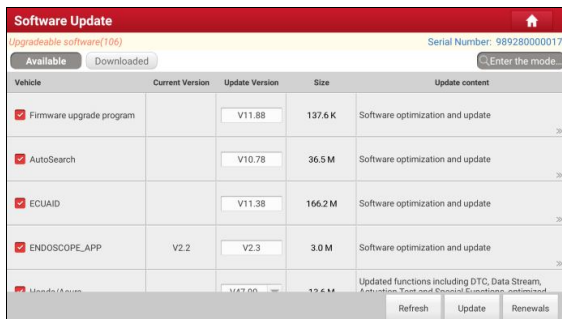

To download certain software that is not frequently used, check the box before the vehicle model. Tap **Update** to start downloading.

Once download is finished, the software packages will be installed automatically.

7.2 Update Frequently Used software

If the user only intends to update the frequently used software, go to Software Update and tap the **Downloaded** tab.

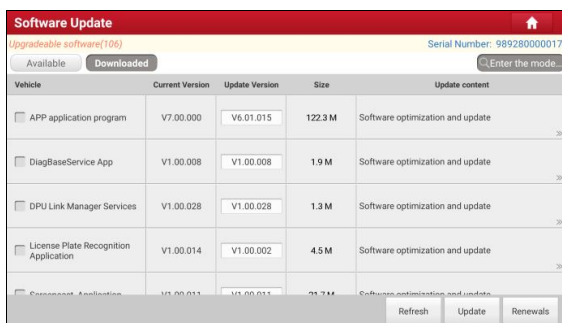

Tap **Update** to start downloading. Once download is finished, the software packages will be installed automatically.

7.3 Renew Subscription

If the software subscription is due or expires, the system will prompt you to renew your subscription.

Tap **Renewal** on the bottom of the screen to enter the payment screen. There are three ways available for you to make payment: PayPal, Subscription Renewal Card (*need to buy it from the local dealer where you purchased the tool) and Credit Card.

1. Using PayPal

1. Select **PayPal**, and then follow the on-screen instructions to finish the transaction.
2. After payment, go to update center to update the diagnostic software.

2. Using Subscription Renewal Card

1. Select **Subscription Renewal Card**.

2. Input the 24-digit pin code of Subscription Renewal Card and then tap Submit to finish the renewal.
3. Go to update center to update the diagnostic software.

3. Using Credit Card

1. Select ***Credit Card***, and then follow the on-screen instructions to finish the transaction.
2. After payment, go to update center to update the diagnostic software.

8 Add-on Modules

8.1 ADAS (Calibration)

This module enables you to effectively and accurately calibrate a wide range of camera-based & radar-based driver assistance systems, e.g. the front camera for the lane departure warning system, the radar sensor for the ACC (Adaptive Cruise Control) or the camera for adaptive headlights. It needs to work with the specific ADAS calibration tool (sold separately).

For more details, please refer to the User Manual included with the module.

8.2 TPMS

This module allows you to configure the tablet as TPMS activation & diagnostic tool, which provides the ability to trigger TPMS sensor, program TPMS sensor, perform the relearning procedure. It needs to work with the compatible TSGUN device (sold separately).

For more details, please refer to the User Manual included with the module.

8.3 BST360 (Battery Tester)

This module allows you to fix battery detection faster and easier. It needs to work with the specific Bluetooth battery tester (sold separately).

For more details, please refer to the User Manual included with the module.

8.4 Videoscope

This module allows you to check those unseen parts of engine, fuel tank, braking system. It needs to work with the compatible Videoscope device (sold separately).

For more details, please refer to the User Manual included with the module.

8.5 S2-2 Sensorbox

This module is specially designed to diagnose and simulator vehicle sensor faults quickly and conveniently. It needs to work with the compatible S2-2 Sensorbox (sold separately).

For more details, please refer to the User Manual included with the module.

8.6 S2-2 Multimeter

This module allows you to measure the physical parameters such as voltage, resistance, frequency etc. It utilizes the same hardware as the S2-2 Sensorbox.

For more details, please refer to the User Manual included with the S2-2 Sensorbox.

8.7 PROG3 (Immobilizer Programmer)

This module allows you to perform the read-write function for vehicle keys, EEPROM, MCU, and EEPROM/FLASH of vehicle engine and gearbox ECU. It needs to work with the specific immobilizer programmer (sold separately).

For more details, please refer to the User Manual included with the module.

9 User Info

This function allows users to manage personal information and VCI.

9.1 My Report

This option is used to view, delete or share the saved reports.

Tap **Report**, there are total 3 options available.

In case the DTC result is saved on Read Trouble Code page, the files will be listed under **Health Reports** tab.

If user records the running parameters while reading data stream, the tablet will save the file which appears under **Recorded Data** tab.

Remote Reports lists all diagnostic reports generated in process of remote diagnosis.

9.2 VCI

This option allows you to manage all your activated VCI devices.

If several VCI devices are activated on this tool, a list of VCIs will be displayed on the screen. Once you choose the VCI that belongs to other account, you have to log out, and then input the right account to continue.

9.3 VCI Management

This option is used for the tablet to deactivate pairing up with the VCI device via Bluetooth.

9.4 Activate VCI

This item lets you activate the VCI device in case you ignore the Activate VCI step in process of the product sign-up.

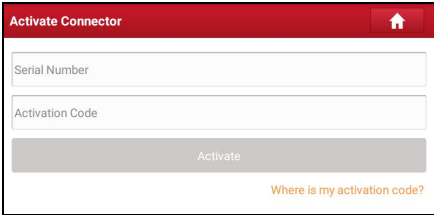

The screenshot shows a mobile application interface for activating a connector. It features a red header bar with the text "Activate Connector" and a home icon. Below the header, there are two text input fields: "Serial Number" and "Activation Code". At the bottom of the form, there is a grey button labeled "Activate" and a link in orange text that says "Where is my activation code?".

Input the Serial Number and Activation Code, and then tap **Activate** to activate the VCI.

9.5 Firmware Fix

Use this item to upgrade and fix diagnostic firmware. During fixing, please do not cut power or switch to other interfaces.

9.6 Data Stream Sample

This feature allows you to manage the recorded data stream sample files.

9.7 My Order

This item allows you to check the status of all your orders.

9.8 Subscription Renewal Card

This item is used to check the status of the subscription renewal card.

Input the 12-digit subscription renewal card number. Tap **Search** to get the search result.

9.9 Profile

Use this item to view and configure personal information.

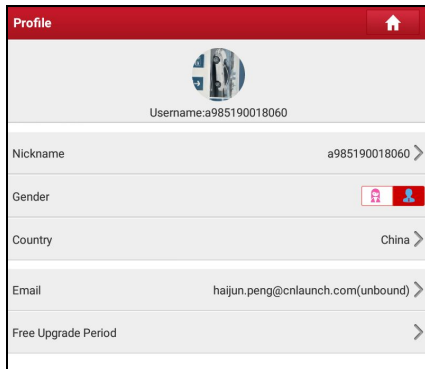

- Tap the user image to change it.
- Tap > next to *Upgrade Period* to check the due date of all diagnostic software.

9.10 Change password

This item allows you to modify your login password.

9.11 Settings

It enables you to make some application settings and view software version information etc.

9.11.1 Units

It is designed to configure the measurement unit. Metric System and English System are available.

9.11.2 Shop Information

This option lets you define your shop information. It mainly includes Workshop, Address, Telephone, Fax and License Plate.

After inputting, tap **Save**.

Once you saved the shop information, it will be entered automatically in the *Add Information* box every time you save the diagnostic report.

9.11.3 Printer Set

This option is designed to establish a wireless connection between the tablet and the Wi-Fi printer (sold separately) while performing printing operations.

The App is compatible with the **LAUNCH Wi-Fi Printer** (sold separately) and **System** (external printer).

For LAUNCH Wi-Fi printer, follow the steps below to connect the printer.

1. Tap **Printer Set**.

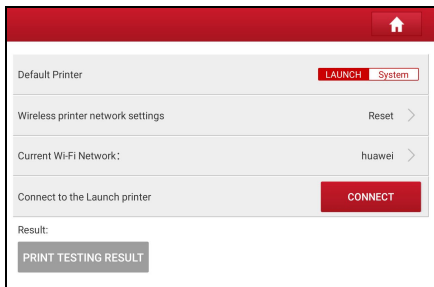

A. If it is the first time you have operated this printer, please proceed the following:

1. For initial use, you are suggested to reset the printer: Press and hold **MODE** & **FEED** for 8 seconds, the following resetting command will be printed out:

at + default = 1

ok

at + reboot = 1

rebooting...

2. Tap **Reset** to configure Wi-Fi printer.

Step 1: Connect the printer:

Tap **Scan** to start scanning and select the desired printer hotspot named with X-431PRINTER-XXXX (XXXX stands for 4 characters), and then tap **Connect** to enter Step 2.

Step 2: Join the Wi-Fi printer into LAN:

Tap **Scan** to select the desired local Wi-Fi network from the list, and type in

the security password (If it is an open network, password is not required), and then tap **Confirm**.

3. Once the Wi-Fi network of the printer is connected and the printer is found, tap **Printing test** to test the printing.

Now the Wi-Fi printer is ready for printing.

If the printer is not found, please reset the printer to default factory settings (refer to Step 2 for details) and check whether the current device and the printer are on the same LAN.

B. If you have configured the Wi-Fi printer to the LAN:

2. Tap **Connect to Printer**:

- a). If the local network remains as it is, tap **Test Print** directly to test the printing.
- b). If the local network changes, you have to reset the Wi-Fi printer.

For other Wi-Fi printers,

Before printing, make sure the following conditions are met:

- The Wi-Fi printer is powered on and working normally.
- The print service plug-in associated with the printer is already installed on the tablet (Go to Google Play or use the Browser to download and install it).

Follow the steps below to proceed:

1. Set the default printer as **System**.
2. Go to **Other Modules -> Tablet Settings -> WLAN**, set the WLAN switch to Off.
3. On the report details page, tap .

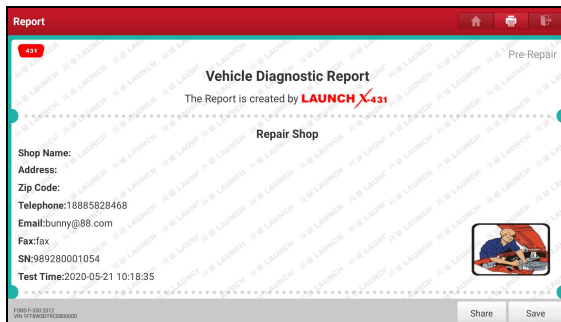

4. Touch  next to **Select a printer** on the upper left corner of the screen.

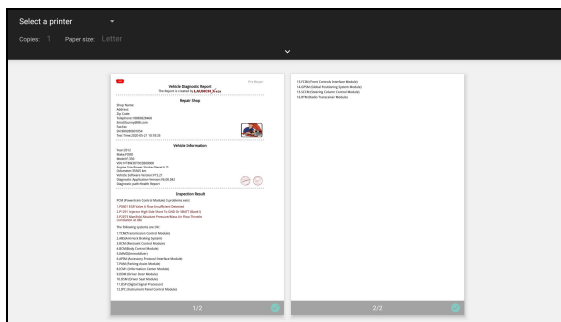

5. Select **All Printers -> Add printer** and enable the installed printer service, the system starts searching for all available Wi-Fi printers of the brand.

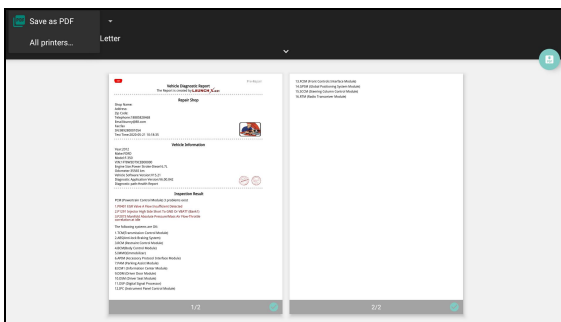

6. Select the desired Wi-Fi printer from the list. If the chosen Wi-Fi printer

hotspot is open, the tablet can connect it directly. If it is encrypted, a password may be required. Refer to the Wi-Fi printer user manual to get the default password.

7. Now the printer is ready for printing.
8. Alternatively, you can also choose **Save as PDF** to save the current diagnostic report as a PDF file for later printing.

9.11.4 Orientation

The option is used to set the screen display orientation.

9.11.5 Clear Cache

This option allows you to clear the App cache. Clearing the cache will restart the App.

9.11.6 About

The software version information and disclaimer are included.

9.11.7 Diagnostic Software Auto Update

This option is used to set whether automatic update function is ON.

9.11.8 Device Account Management

This option is used to manage the sub-accounts. The added sub-account allows the VCI connector to be used by different users to log in the tool, which is convenient for multiple VCIs to perform diagnostic service at the same time.

The newly added sub-account has a one-year validity period. After the expiration, the VCI bound to the sub-account cannot be used and the sub-account will no longer enjoy the rights and interests of the main account. The main account can modify the validity period of the sub-account.

There are two types of sub-accounts: one is an existing account and the other is a newly created account. The main account has the functions of adding and removing sub-accounts, the sub-account can also be unbound from the main account.

Tap **Device account management**, the following screen will appear:

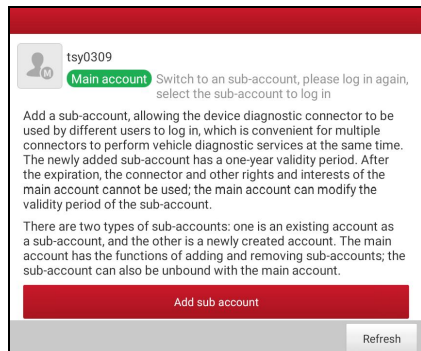

Tap **Add technician account**, the following popup will appear:

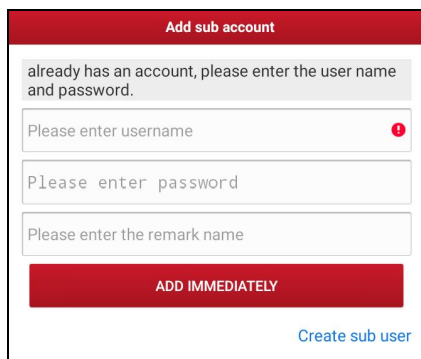

- If you already have an account, please enter the user name and password. After inputting, tap **Add Immediately** to add it as a sub-account.
- If you have not registered any account, tap **Create sub user**. Enter the user name and password, and then tap **Add Immediately** to add it as a sub-account.

After adding the sub-account, the following screen will appear:

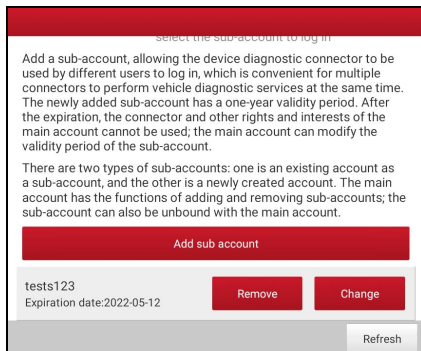

To unbind it from the main account, tap **Remove**. To revise the validity period, tap **Change**.

9.11.9 Login/Logout

To logout the current user ID, tap **Logout**.

To login the system again, tap **Login**.

9.12 Diagnostic Software Clear

This item allows you to hide/clear the diagnostic software that is not frequently used.

 **Note:** Removing software may completely delete the software from the tablet. If some software is not used and the tablet runs out of space, you can use this feature to remove it.

10 FAQ

1. How to save power?

- Please turn off the screen while the tool keeps idle.
- Set a shorter standby time.
- Decrease the brightness of the screen.
- If WLAN connection is not required, please turn it off.
- Disable GPS function if GPS service is not in use.

2. Communication error with vehicle ECU?

Please confirm:

1. Whether diagnostic connector is correctly connected.
2. Whether ignition switch is ON.
3. If all checks are normal, send vehicle year, make, model and VIN number to us using Feedback feature.

3. Failed to enter into vehicle ECU system?

Please confirm:

1. Whether the vehicle is equipped with this system.
2. Whether the VCI dongle is correctly connected.
3. Whether ignition switch is ON.
4. If all checks are normal, send vehicle year, make, model and VIN number to us using Feedback feature.

4. How to download the diagnostic App after resetting the tablet?



Note: Before registration, please make sure the network is properly connected.

After the tablet has been successfully reset, follow the steps below to download the App:

1. Launch the browser and the default official Launch website opens (If a blank page pops up, just type in www.x431.com in the input bar).
2. Tap **Login**, input the username and password and tap **Log In**.
3. Make sure that the serial number is correct, tap **APP application program**

and tap the Download icon to start downloading.

4. After the download is complete, follow the on-screen instructions to install it.
5. After installation, use the existing username and password to login and go to update center to download the diagnostic software.

5. What to do if the language of vehicle diagnostic software does not match the system language?

English is the default system language of the tool. After the system language is set to the preference language, please go to the update center to download the vehicle diagnostic software of the corresponding language.

If the downloaded diagnostic software is still displayed in English, it indicates that the software of the current language is under development.

6. How to retrieve the login password?

Please follow below steps to proceed in case you forgot the login password:

1. Tap the application icon on the home screen to launch it.
2. Tap **Login** on the upper right corner of the screen.
3. Tap **Retrieve password**.

Warranty

This warranty is expressly limited to persons who purchase LAUNCH® products for purposes of resale or use in the ordinary course of the buyer's business.

LAUNCH® electronic product is warranted against defects in materials and workmanship for one year (12 months) from date of delivery to the user.

This warranty does not cover any part that has been abused, altered, used for a purpose other than for which it was intended, or used in a manner inconsistent with instructions regarding use. The exclusive remedy for any automotive meter found to be defective is repair or replacement, and LAUNCH shall not be liable for any consequential or incidental damages.

Final determination of defects shall be made by LAUNCH in accordance with stipulated procedures.

Order Information

Replaceable and optional parts can be ordered directly from your authorized tool supplier. Your order should include the following information:

- Quantity
- Part number
- Item description

Customer Service

If you have any questions on the operation of the unit, please contact local dealer, or customer service center:

Tel: 86-755-84557891

E-mail: X431@cnlaunch.com

Statement:

LAUNCH reserves the rights to make any change to product designs and specifications without notice. The actual object may differ a little from the descriptions in the manual in physical appearance, color and configuration. We have tried our best to make the descriptions and illustrations in the manual as accurate as possible, and defects are inevitable, if you have any question, please contact local dealer or after-sale service center, LAUNCH does not bear any responsibility arising from misunderstandings.